



Road-, Air- and Water-based Future Internet Experimentation

Project Acronym: RAWFIE			
Contract Number: 645220			
Starting date:	Jan 1st 2015	Ending date:	Dec 31st, 2018

Deliverable Number and Title	D7.2: Training		
Confidentiality	PU	Deliverable type¹	R
Deliverable File	D7.2_final_v1.pdf	Date	2018-03-22
Approval Status²	1st Reviewer, 2nd Reviewer, Leader, WP	Version	0.3
Contact Person	Eftychia Samartzopanou	Organization	HMOD
Phone	+302106598245	E-Mail	esamartzopanou@dideap.mil.gr

AUTHORS TABLE

Name	Company	E-Mail
Sotirios Glykofrydis	HMOD	sglikofridis@dideap.mil.gr
Anastasios Soulas	HMOD	hntc_rd_research@navy.mil.gr
Eftychia Samartzopanou	HMOD	e.samartzopanou.hmod@gmail.com

¹ Deliverable type: P(Prototype), R (Report), O (Other)

² Approval Status: WP leader, 1st Reviewer, 2nd Reviewer, Advisory Board



REVIEWERS TABLE

Name	Company	E-Mail
Spyridon Kintzios	HMOD	s.kintzios.hmod@gmail.com
Kyriaki Panagidi	HMOD	kakiap@di.uoa.gr

DISTRIBUTION

Name / Role	Company	Level of confidentiality ³	Type of deliverable

CHANGE HISTORY

Version	Date	Reason for Change	Pages/Sections Affected
0.1	2018-03-10	1 st Version	
0.2	2018-03-22	2 nd Version	After reviewers comment
0.3	2018-04-03	Final Version	

³ Deliverable Distribution: PU (Public, can be distributed to everyone), CO (Confidential, for use by consortium members only), RE (Restricted, available to a group specified by the Project Advisory Board).



Abstract:

RAWFIE is a Research and Innovation Action (RIA) that addresses virtually every aspect raised by the FIRE+ (Future Internet Research & Experimentation) call, namely Collaboration on experimental infrastructures, the use of Europe’s Research and Education Network infrastructures and the development of the concept of Experimentation-as-a-Service (EaaS) in order to provide Experimenters with equipment, services, systems and tools on demand, seamlessly and regardless of their geographical location.

The present document describes the training events and the efforts undertaken on RAWFIE platform into the testbed by operators and experimenters, so that the requested experiments can be successfully defined, executed and validated.

In this deliverable, it appears that interested parties (testbed operators and experimenters) are aware on the various details of the functionalities of the existing systems that have been delivered from the the 1st Open Call. Furthermore, users involved are familiar to Unmanned Vehicles (UxV, where ‘x’ represents “A” for aerial or “S” for sea-surface or “G” for grounds), as well as the platform’s functionalities, the relevant configuration options and the experiment lifecycle in general.

Keywords: RAWFIE, RAWFIE Community, FIRE, platform, UxV experimenters, UxV testbeds, Unmanned Vehicles operators



Part I: Table of Contents

1	Introduction.....	7
1.1	Scope and goal of Deliverable D7.2.....	7
1.2	Structure of the deliverable.....	7
1.3	Common abbreviations.....	7
2	DESCRIPTION OF CONDUCTED TRAININGS.....	9
2.1	Indoor Training With USVs.....	9
2.1.1	Training Area.....	9
2.1.2	Course of the Training.....	10
2.1.3	Results.....	11
2.1.4	Images from the Event.....	11
2.2	Indoor Training with UGVs.....	13
2.2.1	Training Area.....	13
2.2.2	Course of the Training.....	14
2.2.3	Results.....	14
2.2.4	Images from the Event.....	15
2.3	Outdoor Training with USVs.....	18
2.3.1	Training Area.....	18
2.3.2	Training Session 1 – NIRIIS Devices.....	18
2.3.3	Training Session 2 – Durius Devices.....	20
2.3.4	Training Session 3 – Flexus Devices.....	22
2.3.5	Results.....	24
2.3.6	Training Session 4 – Venac Devices.....	24
2.3.7	Images from the Event.....	25
3	Lessons Learnt and Recommendations.....	26
3.1	Lessons Learnt.....	26
3.2	Technical considerations and training needs.....	27
4	Conclusions.....	30



List of Figures

Figure 1 : Panoramic view of the large basin. (Photo: DFKI GmbH).....	9
Figure 2 : USV PlaDyPos external parts	10
Figure 3 : Unpacking PlaDyPos fleet.....	12
Figure 4 : PlaDyPos in the large basin of DFKI.....	12
Figure 5 : Guiding PlaDyPos	13
Figure 6- Turtlebot model	13
Figure 7 - Experiment with turtlebot 1	15
Figure 8 – GUI provided by ROS in order to overview the execution of an experiment.....	15
Figure 9 – a) environment navigation limits and main obstacles and b) Turtlebot executing an experiment.....	16
Figure 10 - Mission for testing the abort message	16
Figure 11 - Turtlebot 2 and 3 "crossed line" experiment	17
Figure 12- - Experiment including turtlebot 2,3 and 4	17
Figure 13 : Top view of RAWFIE Testbed in Skaramangas. (Photo: Google Earth).....	18
Figure 14 : Presentation of the NIRIIS USV (source UoA).....	19
Figure 15 : The NIRIIS USV (Source : ALUTS-LSA).....	20
Figure 16 : The DURIOUS USV (Source: MST)	21
Figure 17 : Familiarization of the DURIOUS USV (Source : HMOD)	21
Figure 18 : The NEPTUS mission planner application (Source: MST).....	22
Figure 19 : Launching process of DURIOUS 1 (Source: HMOD)	22
Figure 20 : The FLEXUS USV (Source: INESC-TEC)	23
Figure 21 -Hand-on training with the FLEXUS USV's (Source: HMOD)	24
Figure 22 - The Heavy-Endurance VENAC UAV (Source: HMOD)	25

List of Tables

Table 1: List of abbreviations	7
Table 2 – Lessons Learnt and Recommendations	26
Table 3 - Technical Considerations for UxVs	27



Part II: Executive Summary

This report has been carried out for the achievement of the given aim to describe the efforts and the outcome and to provide lessons learned for future exploitation by six (6) training sessions carried out within the framework of RAWFIE project. Lessons learned extracted by the aforementioned sessions comprise a valuable feedback for further development and update of the RAWFIE platform.

All the data were collected from seven training sessions, which have been conducted in the first half of 2017. The total assets that were used during these sessions are:

- One (1) type of USVs in German’s Research Centre for Artificial Intelligence (DFKI) in Bremen, Germany.
- One (1) type of UGVs in ETOPIA, an art and technology centre in Zaragoza, Spain.
- Four (4) types of USVs at Hellenic’s Ministry of Defence (HMOD) testbed facility in Skaramangas, Greece.
- One 1 type of UAVs at Hellenic’s Ministry of Defense (HMOD) testbed facility in Skaramangas, Greece.

The analysis of the training session consists of:

- The participated personnel,
- Training venue,
- Used devices specifications,
- UxVs and the tested platform functionalities,
- Lessons learnt from the training.



Part III: Main Section

1 INTRODUCTION

1.1 Scope and goal of Deliverable D7.2

The scope of this document is to provide information in detail concerning the assumptions, conditions, challenges, potential issues and methods to overcome objects that emerged during the seven (7) first training sessions.

In these sessions, testbed operators were familiarized with utilities and functionalities of the delivered devices from the round of 1st Open Call. In addition, RAWFIE technical team had the opportunity to interact with the testbed operators and manufacturers in order to resolve UxVs controls hidden issues of an experiment, in a controlled and real life environment (in contrast with virtual).

The collected feedback from the trainees of each event added valuable injects to the developers of the RAWFIE platform regarding improvements that could be adopted into the platform. The incorporation of the improvements into the RAWFIE platform aims to integrate users needs into the existing assets, and to inform the consortium about device types, software and functionalities that can be obtained from the 2nd and 3rd round of Open Calls.

1.2 Structure of the deliverable

Following the introduction (Chapter 1), Chapter 2 provides a detailed description of all training setups. Chapter 3 contains in general, lessons learnt and recommendations by the trainees. Finally, Chapter 4 contains a short summary and conclusions.

1.3 Common abbreviations

Table 1: List of abbreviations

Abbreviation	Meaning
HMOD	Hellenic Ministry of Defence
UoA	University of Athens
MarEH4EU	Maritime Exploration Hall for Europe
RT-ART:	Robotic Testbed in an ART and Technology center
PlaDyPos	Platform for Dynamic Positioning
PlaDyFleet	A fleet of unmanned surface marine vehicles PlaDyPos



This project has received funding from “HORIZON 2020” the European Union’s Framework Programme for research, technological development and demonstration under grant agreement no 645220



UAV	Unmanned Aerial Vehicle
UGV	Unmanned Ground Vehicle
UI	User Interface
UML	Unified Modelling Language
USV	Unmanned (Sea) Surface Vehicle
IOT	In Order To

2 DESCRIPTION OF CONDUCTED TRAININGS

2.1 Indoor Training With USVs

The first indoor training took place on May 24th 2017, at the Research Centre for Artificial Intelligence (DFKI) in Bremen (Germany) with the participation of representatives from the end users-experimenters community (HMOD) and the test-bed operators’ community (DFKI). The training was focused on the familiarization of the users with the functionalities and control of PlaDyPos (one the delivered USVs from the 1st Open Calls).

2.1.1 Training Area

The training was hosted by the Research Centre for Artificial Intelligence (DFKI), in Bremen. This Centre was selected at the 1st Open Calls of the RAWFIE project in the category “Test-bed Additions”. Its 1,300 m² Maritime Exploitation Hall (fig.1) could support the new robotic technology tests on (USV) and under water (UUV). The infrastructure is composed of:

1. a large basin,
2. two separate test basins,
3. a virtual reality laboratory,
4. a pressure chamber as well as complete technical equipment from cranes up to laboratories.



Figure 1 : Panoramic view of the large basin. (Photo: DFKI GmbH)

The core of the facility is the large basin filled with seawater, dimensioning in 23m x 19m x 8m. The large basin contains 3.4 million liters of seawater. This simulates a real environment conditions suitable for research experimentations, of the abovementioned USVs since they provide a controllable and observable area, not subject to changes in weather conditions. In addition, an observatory glass secure window (2m x 3m) close to ground level provides to stakeholders the opportunity to observe the behavior and the progress of the experiments under the surface o the basin.

2.1.2 Course of the Training

Two days before the actual start of the training, University of Zagreb personnel, manufacturer of PlaDyPos (USV) and responsible for the training, made the appropriate preparations in order to achieve the necessary compatibility and readiness for the devices that would be deployed at the testbed’s basin. The needed processes were the integration of testbed localization systems (visual and RF), testing of the wireless communication coverage, integration and testing of all USVs and finally testing the remote experimentation of USVs with RAWFIE platform.

The theoretical part of the training session lasted approximately three and a half hours (3h 30m) and included the following topics:

- a. Introduction to PlaDyFleet and PlaDyPos
- b. Modus operandi of PlaDyPos and hands on
- c. Maintenance and troubleshooting
- d. Other topics, questions-answers and feedback from the trainees.

During the initial session, participants had a first contact with **PlaDyPos**. This USV is an unmanned surface sea vehicle. It moves autonomously or can be controlled remotely (manually) on the water surface. Its dimensions are: 707mm x 707mm x 350mm (W x L x H) and weights in air approximately 25 kg. It consists of:

- a. Carbon-fibre hull containing electronics and batteries (item 1 on Fig.2)
- b. Large marine hatch for easy access to the electronics (item 2 on Fig.2)
- c. Variable flotation inserts (item 3 on Fig.2) allowing various payload options
- d. Four thrusters ensuring fault tolerant redundancy (item 4 on Fig.2)
- e. Wi-Fi antenna for communication with the flag for USV identification (item 5 on Fig.2).

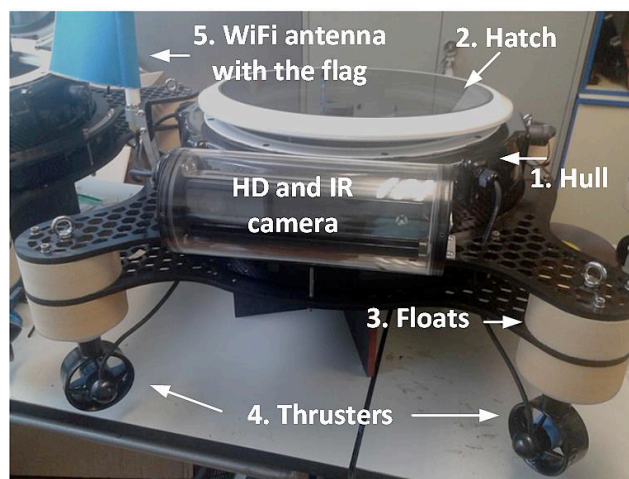

Figure 2 : USV PlaDyPos external parts



Pladyfleet is a fleet of ten (10) unmanned surface marine vehicles of PlaDyPos for RAWFIE infrastructure. USVs are delivered in two testbeds, one indoor (Bremen) and one outdoor (Skaramangas Naval Base).

In the 2nd session, which was the hands on training, participants trained as USVs testbed operators. Particularly, the manufacturer/trainer presented:

- a. USV’s operation modes
- b. The web-based GUI (interface)
- c. The deployment of the USVs in order to perform an experiment
- d. Manual operation (how to drive the USV in a manual mode)
- e. Compass calibration
- f. Recovery of device systems.

During the 3rd session, participants had been lectured about the basic maintenance of the devices, their safe storage, transportation, and troubleshooting. Furthermore, testbed operators were informed on how to handle USVs while not in use.

At the last session, trainees had the opportunity to ask and resolve any questions concerning USV’s operations and provide their feedback about the training process and the devices.

2.1.3 Results

The indoor USV training session was flawless and completed successfully. Two teams from DFKI and HMOD representatives were trained on the PlaDyPos life-cycle use (pre-, during and after its use). Although PlaDyPos wasn’t delivered to HMOD at that time, training helped HMOD team to be prepared for its reception.

In addition, trainers (University of Zagreb) provided to trainees the device user manual, containing most of the topics covered during the training sessions.

2.1.4 Images from the Event

The following images depict snapshots of the indoor training session with USVs.



Figure 3 : Unpacking PlaDyPos fleet

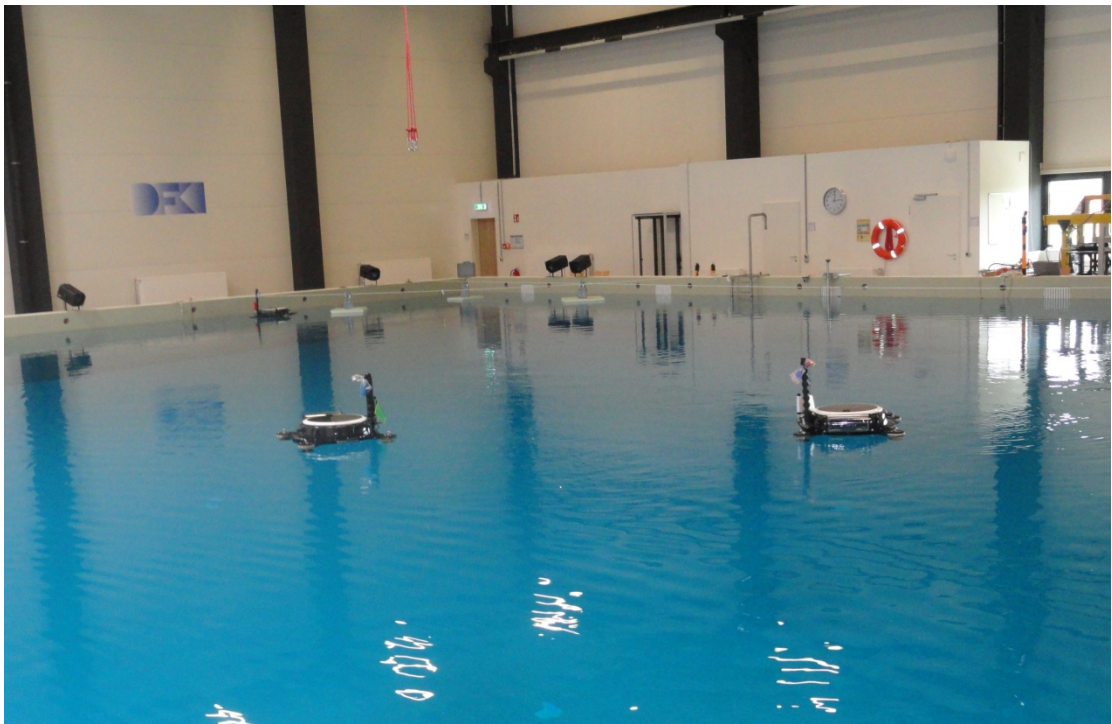

Figure 4 : PlaDyPos in the large basin of DFKI

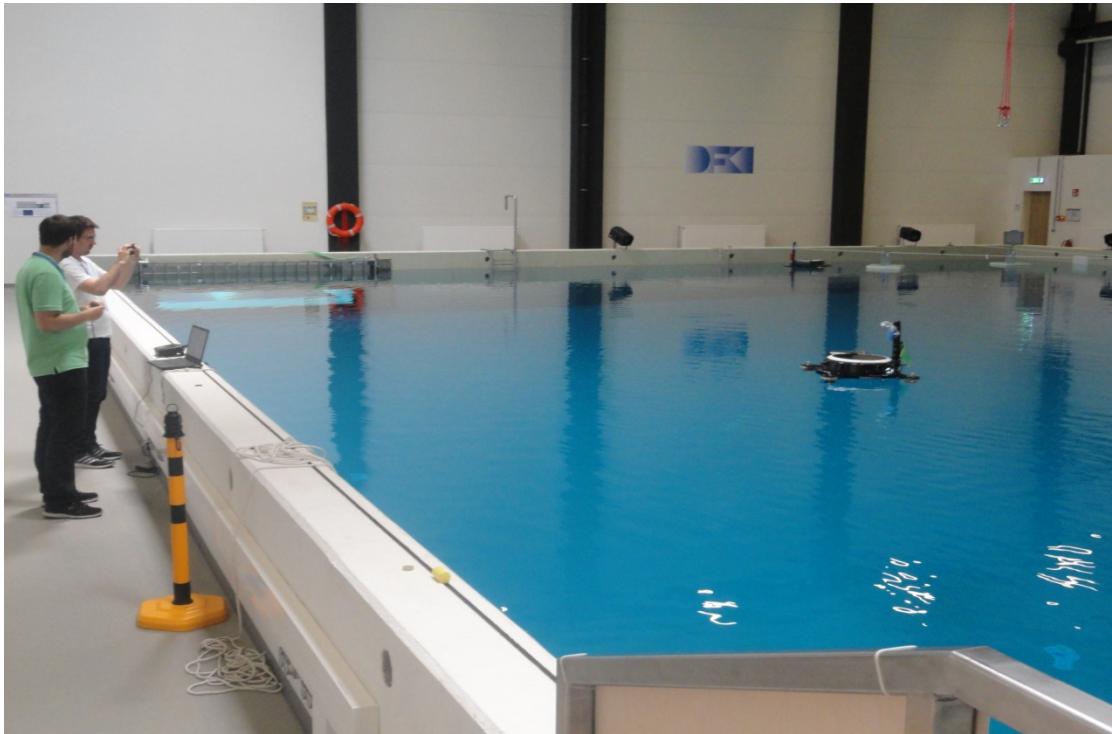

Figure 5 : Guiding PlaDyPos

2.2 Indoor Training with UGVs

The indoor training was conducted during the October of 2017.

2.2.1 Training Area

RTART is a UGV testbed located in Zaragoza, Spain. It provides a realistic environment for ground robot experimentation located in a unique Art and Technology centre, ETOPIA, which is available for ground robotic platforms experimentation. This testbed has four UGV platforms available onsite.

These robots are standard TurtleBot2 platforms (Fig. 6) with an Asus Xtion, Hokuyo Laser UST-20LX as main sensors, and an Intel R PentiumR NUC for on-board processing.

Besides assistance with the experimentation, the testbed has monitoring tools available as well as pre-computed maps for every scenario.

These maps are built in advance using standard ROS mapping nodes based on 2D laser scan. They represent the environment navigation limits and main obstacles, as shown in the example in Fig. 9(a). These maps are stored in standard ROS formats, to enable the robot autonomous navigation, including obstacle avoidance, as well as to provide the base information required by the final user navigation interface.



Figure 6- Turtlebot model



2.2.2 Course of the Training

RTART testbed was the first prepared testbed equipped with UGVs only. Many of the validation and verification tests during the development period conducted in this testbeds from RAWFIE technical team. In order to run an experiment, a few steps need to be run from the local testbed and from the remote experimenter sides.

On the testbed support side, before the user can launch the experiment, the robots just need to be brought up. In this testbed, besides the basic bring up of the robot, a standard ROS localization node based on the adaptive Monte Carlo localization approach is launched to localize the robot within the scenario map, and enable the autonomous navigation capabilities.

On the user side, the experimenter just needs to select the testbed, configure the UGV nodes that should be used, select the data that wants to receive and launch the experiment. Most of these features are represented on the GUI screen-shots in Fig. 7. As shown in Fig. 7, the GUI, available for the remote experimenters includes a 2D representation of the scenario layout where the target way-points can be set.

2.2.3 Results

Numerous experiments have been performed to validate the correct integration of all the components and verify the remote experiments can be performed seamlessly. For each experiment, the following issues have been always verified (from the remote experimenter side):

- The remote GUI used by the experiment receives all the sensory information requested on the configuration of the experiment (see example in Fig. 7).
- The remote GUI used by the experiment gets the proper notifications of termination of the mission (see example in Fig. 8) from the testbed operator side
- The robots finish the missions with the acceptable error threshold set up on the configuration (10cm in these particular experiments).

Additionally, there have been specific tests which successfully verified other management features such as:

- Interrupting the commands at any time during execution (i.e, remotely abort the mission for example for safety reasons).
- Stop a mission and re-send an updated plan to continue where the robot had stopped.

Fig. 9b shows details from one of the first validation experiments. Successful experiments have been run in several scenarios with different number of UGVs (as the examples shown in Fig. 8 or Fig. 7).

2.2.4 Images from the Event

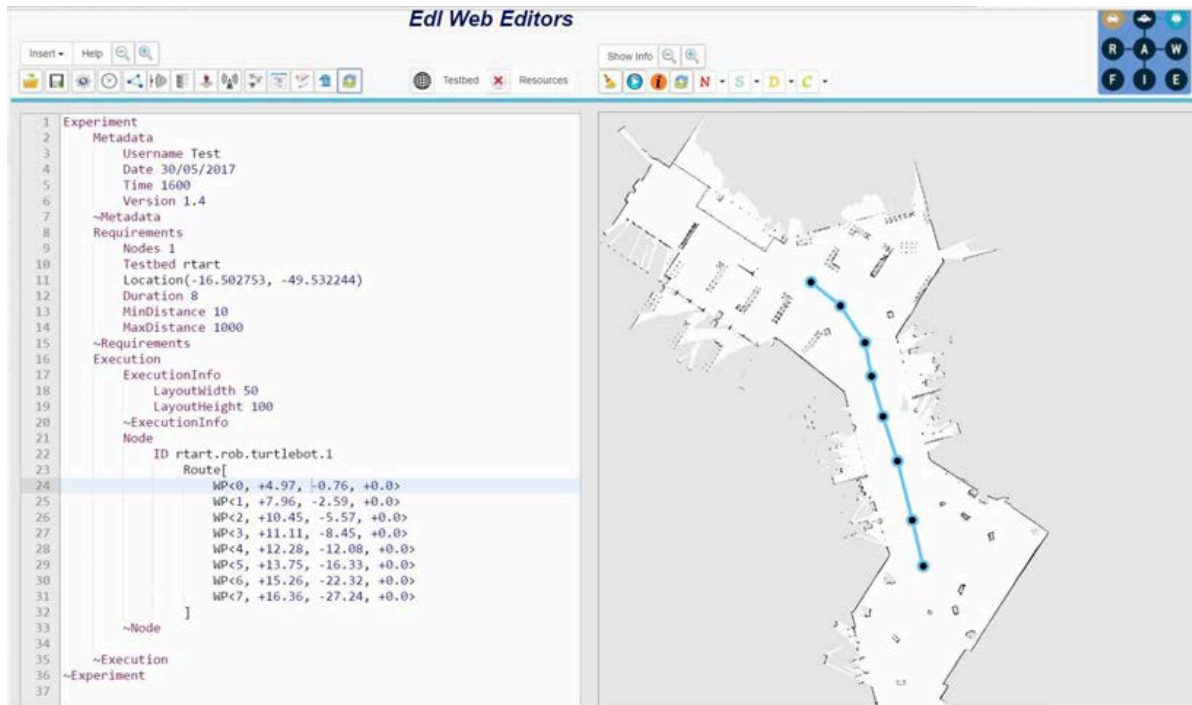

Figure 7 - Experiment with turtlebot 1



Figure 8 – GUI provided by ROS in order to overview the execution of an experiment

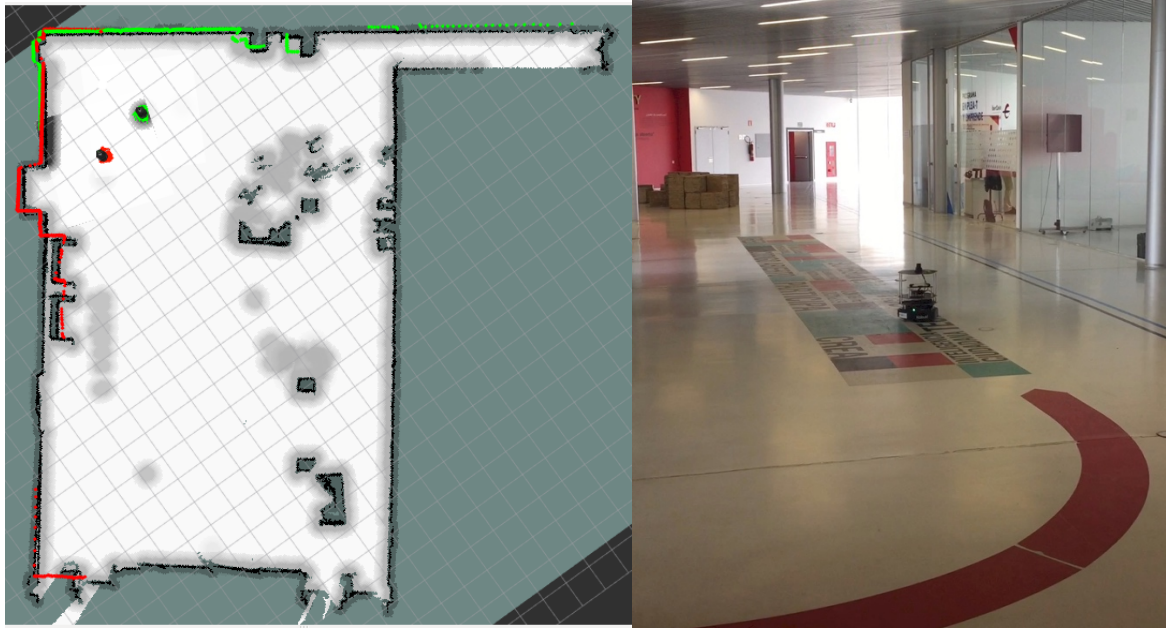

Figure 9 – a) environment navigation limits and main obstacles and b) Turtlebot executing an experiment

```

Experiment
  Metadata
    Username test
    Date 06/10/2017
    Time 1100
    Version 0.81
  ~Metadata
  Requirements
    Nodes 1
    Testbed rtart
    TestbedArea RT_ART_main_area2
    Location(+41.6591, -0.9062)
    Duration 15
    MinDistance 10
    MaxDistance 1000
  ~Requirements
  Execution
    ExecutionInfo
      LayoutWidth 50
      LayoutHeight 100
    ~ExecutionInfo
    Node
      ID rtart.rob.turtlebot.2
      Route[
        WP<0, +0.99, -2.05, +0.0>
        WP<1, -0.38, -4.39, +0.0>
        WP<2, -2.13, -6.57, +0.0>
        WP<3, -4.05, -8.95, +0.0>
        WP<4, -5.66, -11.16, +0.0>
        WP<5, -6.58, -13.06, +0.0>
        WP<6, -4.16, -14.22, +0.0>
        WP<7, -3.22, -13.03, +0.0>
        WP<8, -4.20, -12.28, +0.0>
      ]
  
```



Figure 10 - Mission for testing the abort message

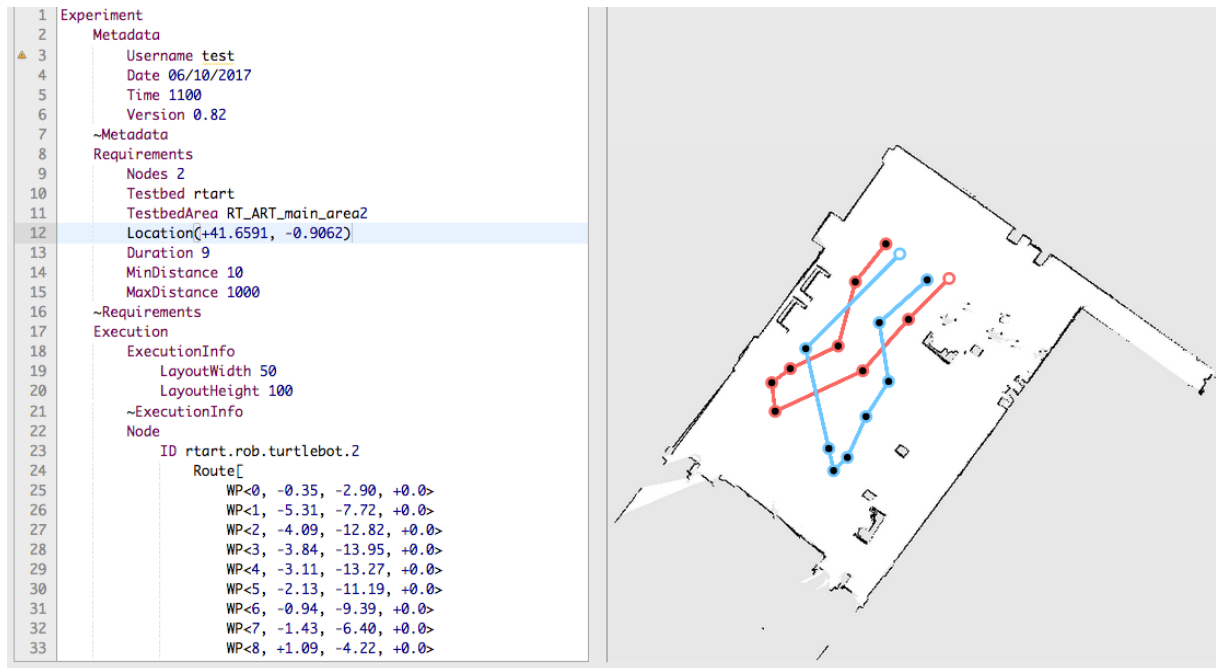

Figure 11 - Turtlebot 2 and 3 "crossed line" experiment

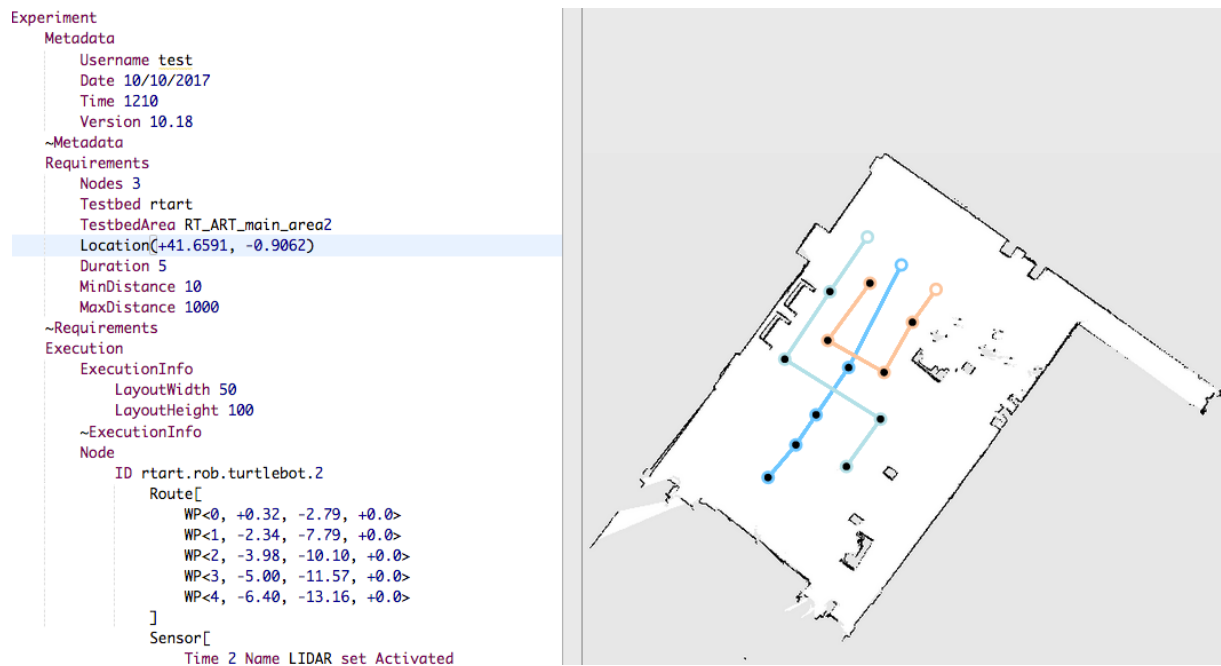

Figure 12- - Experiment including turtlebot 2,3 and 4

2.3 Outdoor Training with USVs

The outdoor trainings were conducted during the second half of 2017, at Skaramangas Naval Base (HMOD), in Athens, Greece. In this session, trainees used the PladyPos, the NIRIIS, the DURIUS the FLEXUS USVs and the VENAC UAVs in the testbed facilities.

2.3.1 Training Area

The Skaramangas Naval Base infrastructure will be the unique RAWFIE Testbed in Greece with three different types of UxVs. It covers 220.337 m² of sea and land utilizing 100% Wi-Fi coverage and is capable to host and deploy every type of UVs: air, land, sea and subsurface. The infrastructure is supported by a large conference room and two classrooms. Furthermore, an independent space (about 67 cubic meter volume) capable to store at least 20 UxVs. This store space is close to the deploy sea basin and the jetty’s storage which is also used as storage and maintenance facility for the UxVs fleet. A provision for UAV flights is also made inside the testbed’s geographical limits (up to 300ft-AMSL).



Figure 13 : Top view of RAWFIE Testbed in Skaramangas. (Photo: Google Earth)

2.3.2 Training Session 1 – NIRIIS Devices

In between 20, 21 of July 2017 the first outdoor training took place at the HMOD testbed facilities in Skaramangas with the participation of the UoA RAWFIE Team and the HMOD testbed operators.

The fleet of ten (10) USV’s and the relevant equipment were delivered inside a single trailer which provided with ease of access and flexibility in transportation. The course was implemented by ALTUS – LSA and it was conducted in three phases. More specific, the first phase was the theoretical training of operators followed by the hands-on training at sea

(phase two) and concluded to the maintenance activities (phase three) of the NIRIIS USV’s. Upon completion, attendance certificates were given to the trainees by ALTUS – LSA.

Preparatory actions have been set in order to deploy NIRIIS USVs in the testbed.

During the first part of the training, the trainer presented the NIRIIS USV, its components and a detailed system overview which included the following items:

- a. USV’s function modes
- b. Mission planner application
- c. USVs experimentation deployment
- d. Manual operation (emergency drive)
- e. Recovering the USVs
- f. USV pre-deployment mandatory inspection procedure
- g. USV maintenance.



Figure 14 : Presentation of the NIRIIS USV (source UoA)

At the second session the participants had a hands-on training experience. NIRIIS hull is built according to the hydrodynamic principles for reaching high speeds and providing increased stability. It is made by glass reinforced polyester fiber (GRP), that increases durability and flexibility, while it can carry payloads up to ten kilograms. Each USV has a total length of 135cm, and a gross weight of 10.5 kg (batteries included). The USV reaches speeds up to 16knots (about 30km/h) and has an endurance of 120 minutes. It consists of:

- a. GRP fiber hull containing batteries, electro-mechanical parts for propulsion and steering module
- b. Daylight Wide Field of View (WFOV) camera
- c. IR (infra-red) camera

- d. Two telemetry antennas
- e. Video link antenna

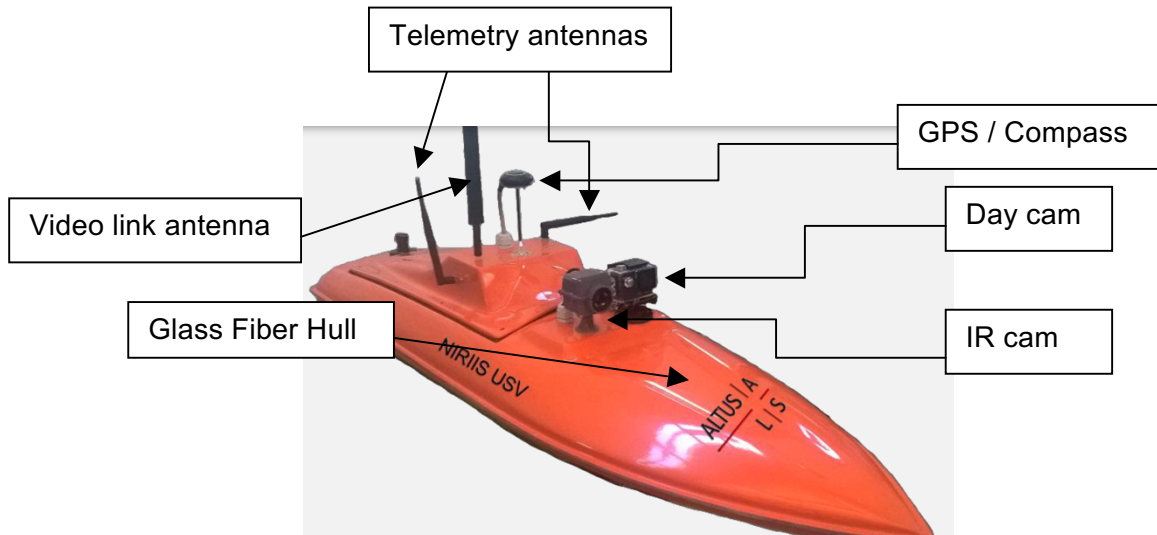

Figure 15 : The NIRIIS USV (Source : ALUTS-LSA)

At the third session the testbed operators had the opportunity to prepare and launch a USV with the guidance of the ALTUS-LSA representative.

2.3.3 Training Session 2 – DURIOUS Devices

During July 2017 (between 27th and 29th) the second outdoor training was held to the HMOD testbed. The training was provided by the OCEAN SCAN Marine Systems & Technology (MST). The session was focused on the same as aforementioned training framework: theoretical training of the operators, hands-on training at sea and the maintenance of the DURIOUS USV’s.

MST delivered two USV’s (DURIOUS1 & 2, fig. 10) with their related components and equipment to the HMOD testbed. The DURIOUS USV is a “torpedo” shaped catamaran, which floats with its cylinders semi-submerged. The total length of DURIOUS extends to 150cm and the dead weight reaches 45kg. It can carry payloads up to 15kg. The maximum speed is up to 3knots and it can be operated up to five hours (300min) on that speed. It consists of two metal cylinders where the batteries are enclosed. For the propulsion and steering two single thrusters are provided. A water-proof box on the top-middle area includes the USV’s electronics. The dual band Wi-Fi antenna and the USV’s status lights are mounted on the top side.

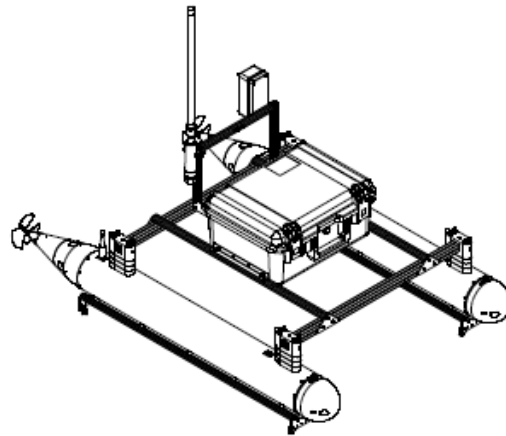

Figure 16 : The DURIOUS USV (Source: MST)

At the first session the MST trainer provided a quick breakdown of DURIOUS USV. Moreover a system overview and an initial familiarization with the NEPTUS mission planner application took place. Finally the basic pre-determined maneuvers were explained. In more detail the session covered the following items:

- a. USV’s function modes,
- b. Mission planner application,
- c. USVs experimentation deployment,
- d. Manual operation (emergency drive),
- e. Recovering the USVs,
- f. USV pre-deployment mandatory inspection procedure.



Figure 17 : Familiarization of the DURIOUS USV (Source : HMOD)

At the second session the trainees had the opportunity to initialize and create a mission on the NEPTUS mission planner application. Also they had a more detailed presentation of the pre-determined maneuvers of the DURIUS USV.

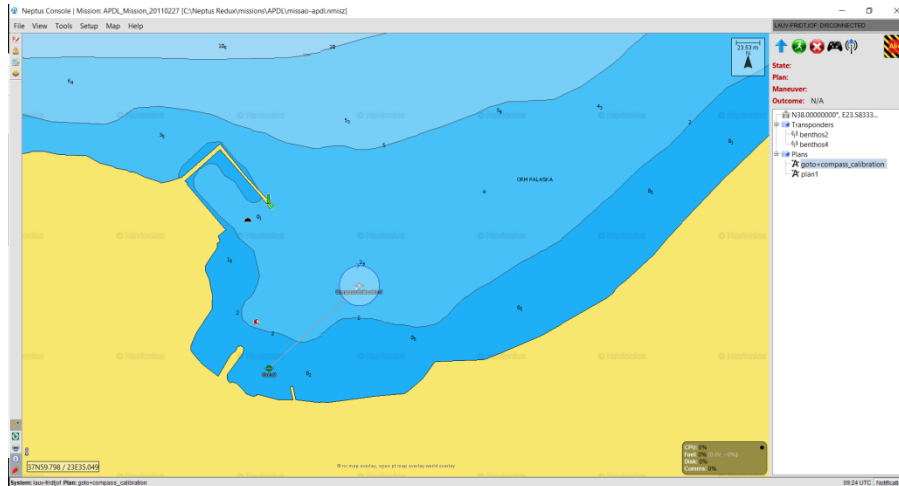

Figure 18 : The NEPTUS mission planner application (Source: MST)

The third session was the hands-on training. Pre deployment checks and deploy procedure was covered. The final action was the DURIUS USV launching at the sea basin. Few issues concerning the ease and safe launch have been resolved on site.



Figure 19 : Launching process of DURIUS 1 (Source: HMOD)

2.3.4 Training Session 3 – FLEXUS Devices

The third outdoor training started on 05th and ended on 8th of August 2017 in the same facility. The training was provided by INESC-TEC and covered the above mentioned topics (specifications and breakdown, capabilities and checks, pre-launch tests, launch, recovery and basic maintenance) of FLEXUS (FLEXible Unmanned Surface vehicles for the IoT-moving) USV’s. INESC-TEC delivered ten USV’s in to three configurations (fig. 13). Each configuration is equipped with a different set of sensors. More specific:

1. Imaging sensor pack (USVs #1, #2, #3 and #4), which implements an HD camera.
2. Air monitoring sensor pack (USVs #5, #6 and #7), that includes a CO probe, a CO2 probe and a temperature sensor.
3. Water monitoring sensor pack (USVs #8, #9, and #10), that includes a pH probe, a conductivity probe and a temperature sensor.



Figure 20 : The FLEXUS USV (Source: INESC-TEC)

Vision USV

Air – monitoring USV

Water – monitoring USV

FLEXUS USV is a catamaran shaped USV. The dimensions of the hull are 90 x 80 cm (L x W). The gross weight is about 15kg. It reaches speeds up to 3 knots and the endurance time is about 3hours (180min).

During the training session, INESC-TEC followed also the same methodology. Firstly, a detailed system overview and the mission preparations activities were given. Then, trainers presented the composition of FLEXUS USV and the following topics:

- a. USV’s function modes,
- b. Mission planner application,
- c. USVs experimentation deployment,
- d. Manual operation (emergency drive),
- e. Recovering the USVs,
- f. USV pre-deployment mandatory inspection procedure.

Hand-on training was the second session. FLEXUS USVs launch preparation and the launch at sea took place.



Figure 21 -Hand-on training with the FLEXUS USV's (Source: HMOD)

2.3.5 Results

The outdoor three USV training sessions were completed successfully. HMOD testbed operators were trained on the FLEXUS, DURIUS and NIRIIS life-cycle use (pre-, during and after its use).

2.3.6 Training Session 4 – VENAC Devices

On 04 of December 2017 Wizzit company delivered three VENAC UAV's to the HMOD testbed. There were two ultra-light and one Heavy Endurance variant. On that day Wizzit presented the UAVs to the testbed operators and performed a demonstration flight.

The VENAC family UAVs come in to two different configurations. An ultra-light Hyper Efficient UAV that can hover for 90mins and a Heavy Endurance UAV that can hover for 120 mins and has a vertical take-off capability of 4kgs. The ultra-light variant weights 2 kg, has a maximum payload of 3 kg with a size of 68cm X 48cm. The Heavy Endurance variant weights 5,2 kg has a maximum payload of 9,2 kg with a size of 96,2cm X 97cm.

2.3.7 Images from the Event



Figure 22 - The Heavy-Endurance VENAC UAV (Source: HMOD)

3 LESSONS LEARNT AND RECOMMENDATIONS

3.1 Lessons Learnt

The training provided by the USV manufactures to the testbed operators was fruitful and proved to be very beneficial especially in terms of proper handling of the equipment and the integration of each system to the RAWFIE platform.

One of the most important demands that emerged through the training sessions was the need of evolving operating procedures for launching and recovering the USVs according to the type and the place of launch or recovery.

In addition, the proper preparation (battery charging, pre-launch checks, emergency recovery procedures/measures) should be in place.

Lessons learnt are shown in more detail in the following table:

Table 2 – Lessons Learnt and Recommendations

Area of interest / impact	Key Learnings	Remarks- Recommendations for Future Projects
Training Management / Planning	Strengths: <ul style="list-style-type: none"> • Sufficient duration • In detail • Certification Areas to improve: <ul style="list-style-type: none"> • Training Material and harmonization • Personnel familiarization 	<p>The duration of the training session was sufficient and supported by a detailed and experiential, mindful and engaging guidance.</p> <p>However, only one of the trainers provide to testbed operators certificates.</p> <p>The training material should be sent prior to manufacturers arrival IOT achieve a better level of understanding.</p> <p>Also, training material should be provided in the same format (digital or hard copy).</p>
Training Communication	Strengths: <ul style="list-style-type: none"> • After trainee support Areas to improve: <ul style="list-style-type: none"> • Trainers evaluation 	<p>Upon completion of each training, the trainers remained (until present day) at the trainees’ disposal through electronic means of communication for clarifications whenever they arose.</p> <p>A training evaluation process as</p>



Area of interest / impact	Key Learnings	Remarks- Recommendations for Future Projects
		a training feedback survey should be in place IOT improve future sessions.
Site Requirements	<p>Strengths:</p> <ul style="list-style-type: none"> Air, land and seaborne testbed Safe and Secure area <p>Areas to improve:</p> <ul style="list-style-type: none"> Early METEO notification 	<p>The test bed area is suitable for all kind of UxVs. It extends in a large and secure area where HMOD grants full control.</p> <p>However, an early METEO prediction should be in place to ensure the unhampered UAVs flight operation.</p>
Trainees Requirements	<p>Strengths:</p> <ul style="list-style-type: none"> For UGVs, USVs: Basic skills <p>Areas to improve:</p> <ul style="list-style-type: none"> For UAVs only: Operator’s experience <i>Regarding the UAV’s trainings, the trainees</i> 	<p>Regarding the USV’s trainings there was not a specific educational threshold for the trainees.</p> <p>Concerning UAVs operator’s experience is needed to avoid accidents and equipment degrade.</p> <p>Suggestion: Learners are endorsed to be guided according to ATP 338 I (Guidance for the training of Unmanned Aircraft Systems Operators). <u>IOT meet the minimum level of understanding</u></p>

3.2 Technical considerations and training needs

Table 3 - Technical Considerations for UxVs

<u>Model Name</u>	<u>Technical Issue</u>	<u>Recommendation</u>
Altus LSA-NIRIIS	Absence of proper lubricants for the hydrojet thruster.	Manufacturer should provide



		adequate quantities of lubricant estimating to last until the end of the program (12/18) also to provide the Testbed operators with the specifications of it.
	The lack of a dedicated recovery procedure when more than one NIRIIS USVs are used, hampers and delays the whole process. In particular, all USVs are controlled together by one remote control without the ability to select one at a time.	The manufacturer should propose a method to handle more than one USVs simultaneously in a quick and safe manner
	Since there is only one charger available (with two charging stations) and each USV demands three batteries (two main and one auxiliary) the preparation time for an experiment may last for more than one day.	The manufacturer should provide the Testbed operators with more charging devices.
MST-DURIUS	Absence of manuals	The manufacturer should provide the testbed operators with system and use manuals
	Absence of pre-deploy check procedures	The manufacturer should provide the testbed operators with checklists concerning the preparation of the USV before launching to the sea
	Absence of manual control mode (emergency control capability)	The manufacturer should provide the testbed operators with a manual control access to the USV.
	Absence of log books (the DURIUS USV soft-	The manufacturer should provide the testbed operators with log-



This project has received funding from “HORIZON 2020” the European Union’s Framework Programme for research, technological development and demonstration under grant agreement no 645220



	logs all activities)	books
PladyPos	Absence of log books	The manufacturer should provide the testbed operators with log-books



4 CONCLUSIONS

The training as a whole requires its own designed experience and objectives. The depth and experience of training session should vary according to the length of the engagement and the desired level of professionalism.

The training sessions were well structured and time satisfactory. Almost every session was supported by the proper amount and the quality of training material (manuals, presentations etc.). We must not omit to mention the fact of the well prepared, detailed and very supportive instructors. Another point to mention is the direct relation of the audience to the project which resulted to a higher than expected outcome for the project continuing.

The impact of the training course was direct to the project since it followed by the experimentation period. However, if the familiarization period was longer, the training could be more beneficial and the impact bigger than the expected.

Concluding, the training process must be considered as an add-in value for the project and the trainees, as it succeeded to provide all the needed skills and knowledge in a short period of time. At the same time basic maintenance topics covered, which results in the availability and the flawless operation of the RAWFIE platform.